

# phyFLEX Carrierboard

## PBA-B-01.A3

Copyright 2013 PHYTEC TECHNOLOGIE HOLDING AG

INFORMATION IN THIS DOCUMENT IS PROVIDED SOLELY FOR USE IN CONJUNCTION WITH THE PHYTEC PRODUCT DESCRIBED HEREIN. NO INTELLECTUAL PROPERTY RIGHTS -- EXPRESS OR IMPLIED -- ARE GRANTED THROUGH THIS DOCUMENT. LIKEWISE, PHYTEC MAKES NO EXPRESS OR IMPLIED WARRANTIES OF ANY KIND, WHETHER AS TO MANUFACTURABILITY; MERCHANTABILITY; FITNESS FOR A PARTICULAR PURPOSE; OR INFRINGEMENT OF ANY PATENT, COPYRIGHT OR OTHER INTELLECTUAL PROPERTY RIGHT. SPECIFICATIONS HEREIN ARE SUBJECT TO CHANGE AT ANY TIME WITHOUT NOTICE.

PHYTEC		PHYTEC Messtechnik GmbH Robert-Koch-Strasse 39 D-55129 Mainz
Project:	phyFLEX Carrierboard	Department: F&E
13.05.2013	PCB-No.: 1364.4	Author: M.Achilles
		Revision: 4
		Sheet 1 of 16

A

B

C

D

A

B

C

D





### Current Sense VCC12\_IN

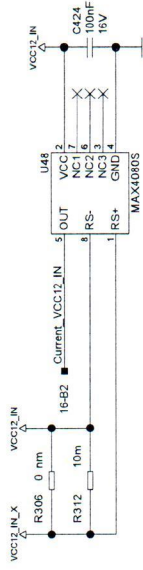

### Current Sense VCC12\_POE

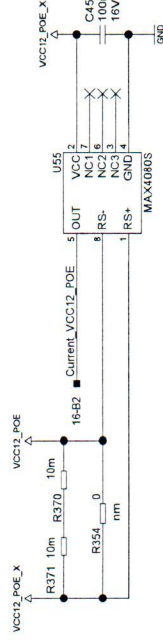

### Current Sense VCC3V3

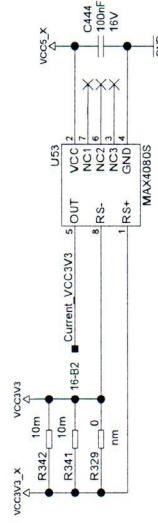

### Current Sense and Switch VCC5

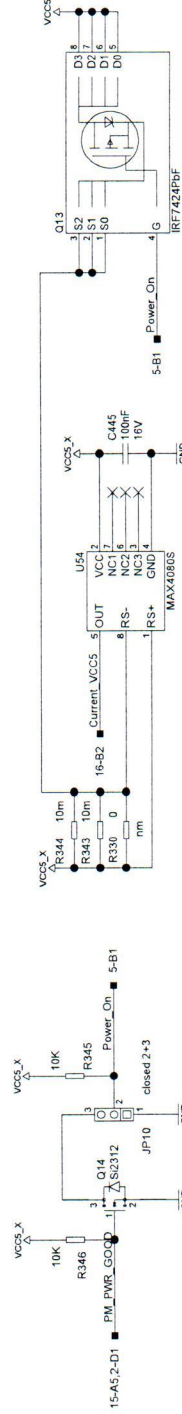

### DC POWER IN 12V

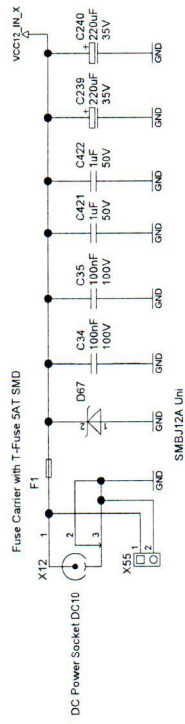

<b>PHYTEC</b>	
PHYTEC Messtechnik GmbH Robert-Koch-Strasse 39 D-55129 Mainz	
Projekt: phyFLEX Carrierboard	
13.05.2013 PCB-No.: 1384.4	
Revision: 4	
Author: M.Achilles	
Department: F&E	
Revision: 4	
Sheet 3 of 16	

# POE

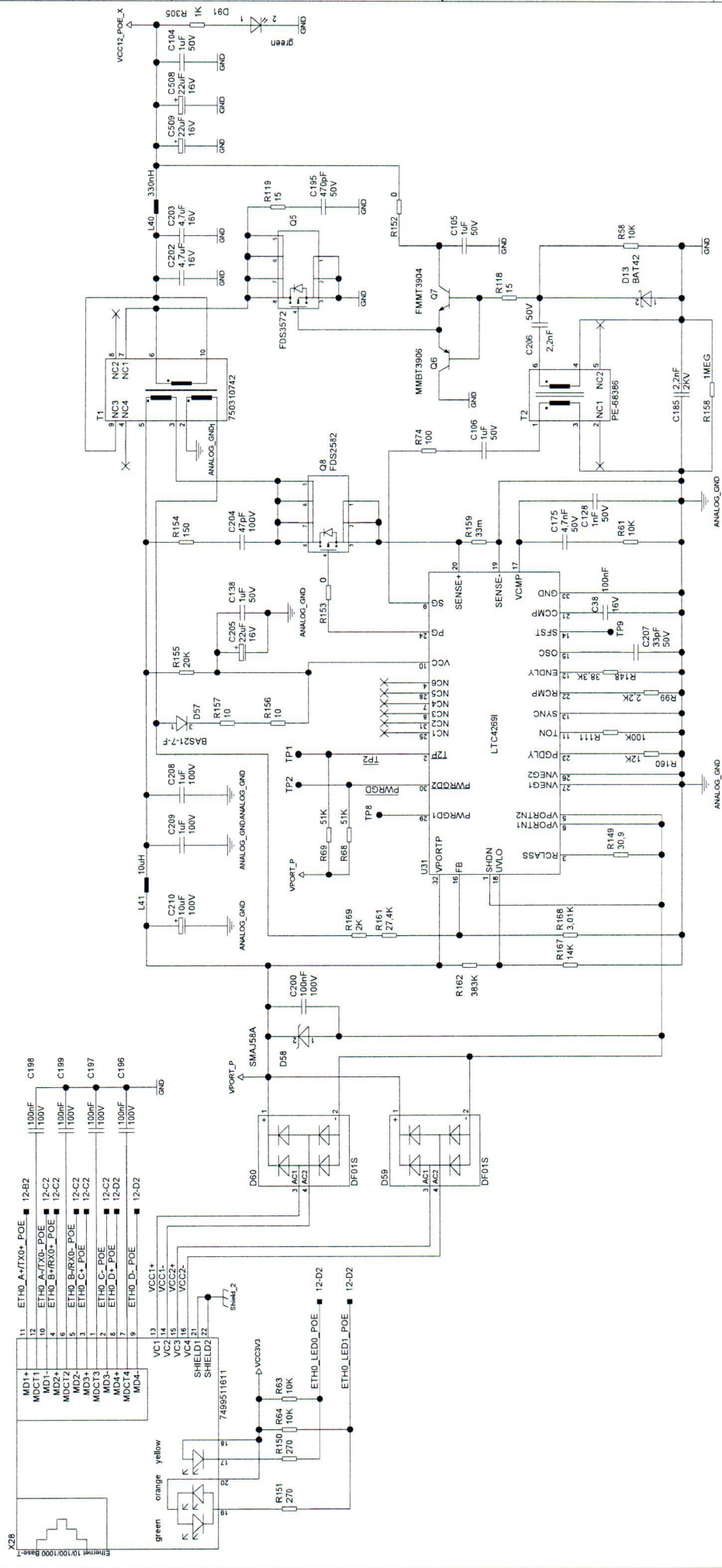

A

B

C

D

A

B

C

D

<b>PHYTEC</b>	
PHYTEC Messtechnik GmbH Robert-Koch-Strasse 39 D-55129 Mainz	
Project:	phyFLEX Carrierboard
13.05.2013	PCB-No.: 1.354.4
Revision 4	Sheet 4 of 16



# 5V/3V3 Regulator 8A

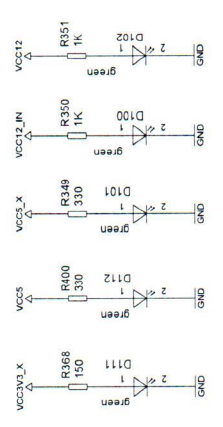
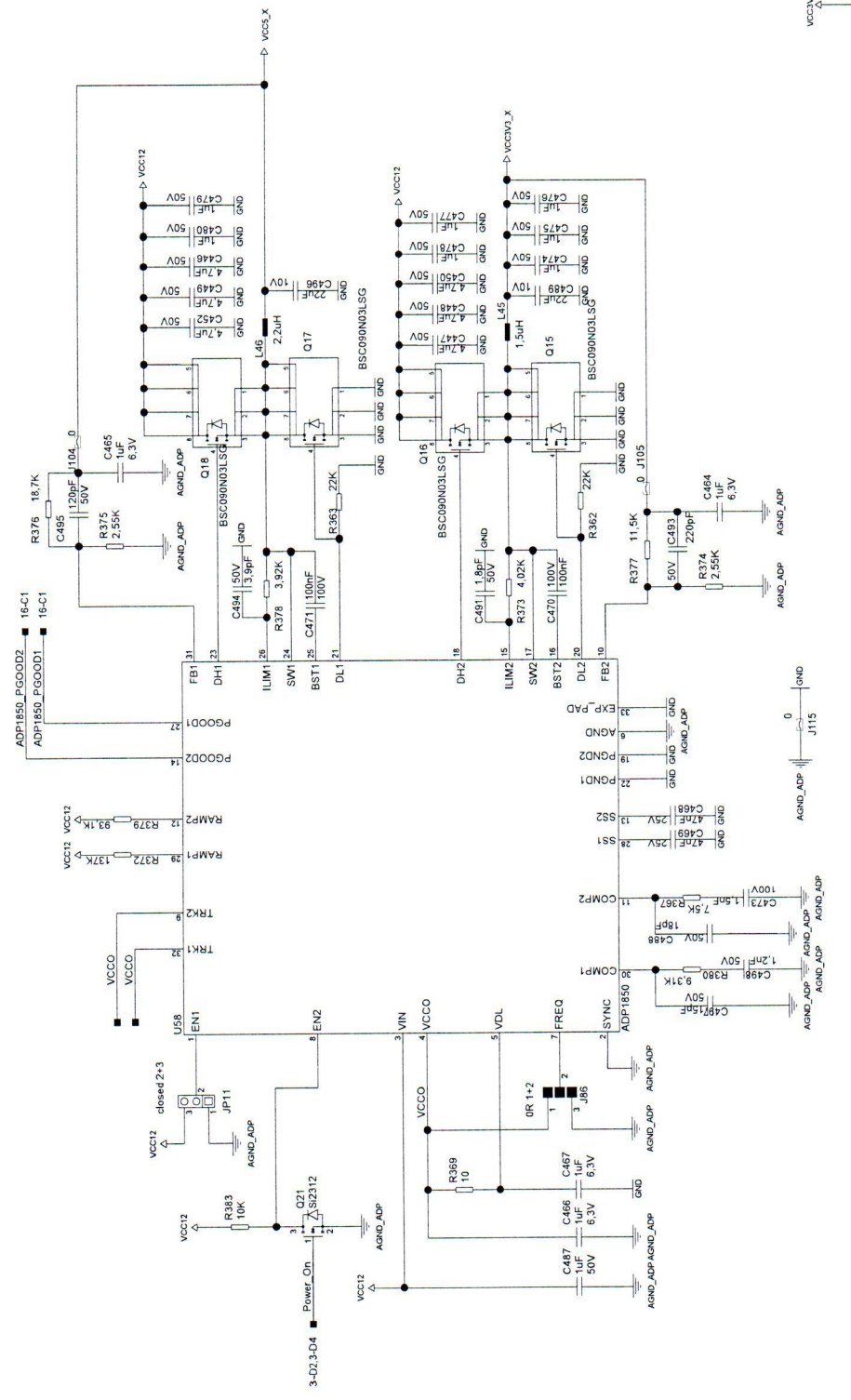





# I2S Audio

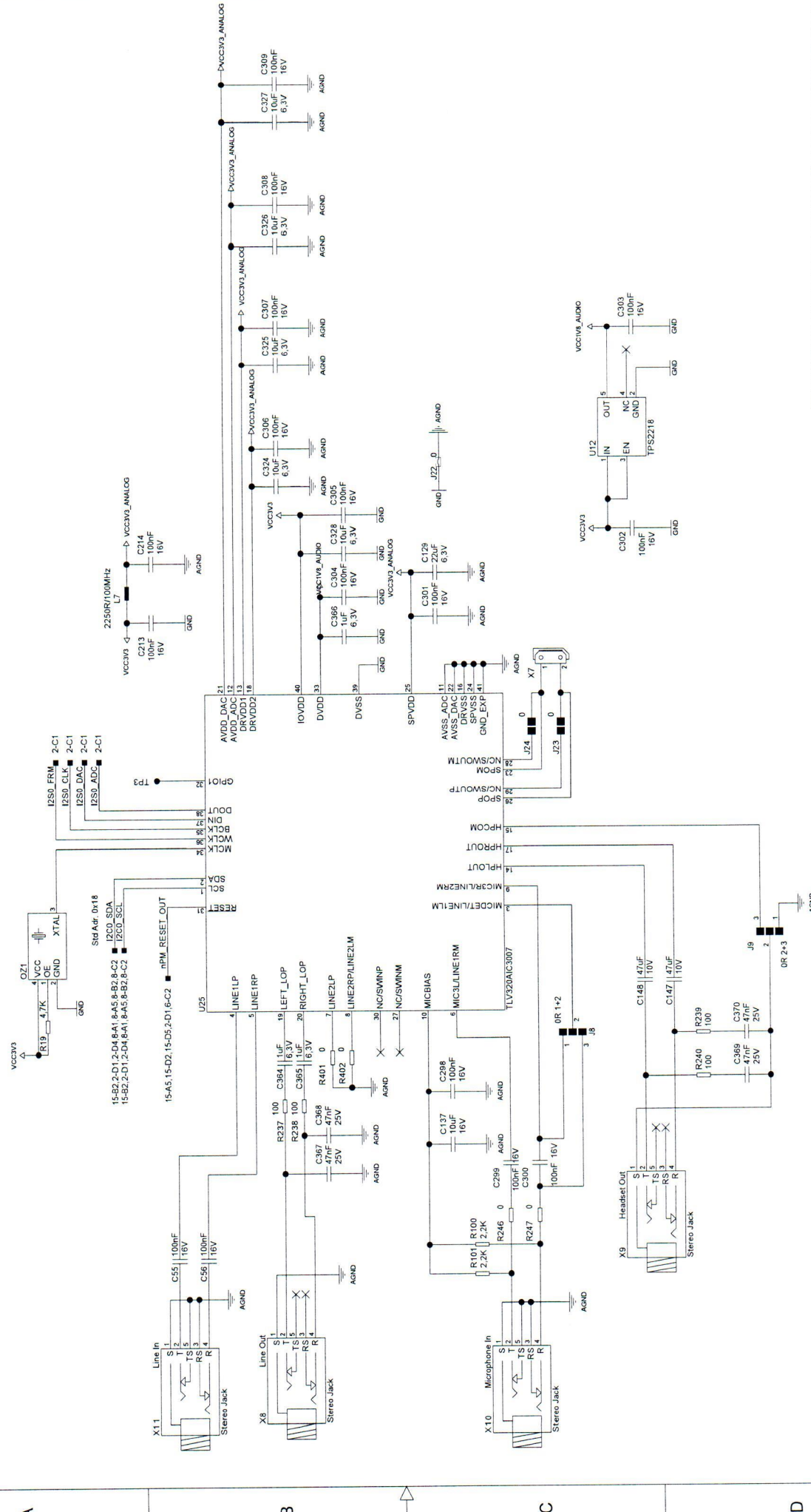

PHYTEC		PHYTEC Messtechnik GmbH Robert-Koch-Strasse 39 D-55129 Mainz
		Department: F&E Autor: M.Achilles
Project:	phyFLEX Carrierboard	Revision 4
13.05.2013	PCE-No: 1.384.4	Sheet 7 of 16

# LCD Adapter

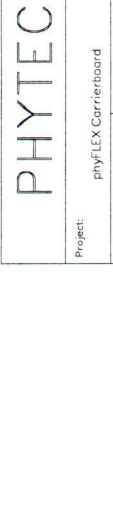
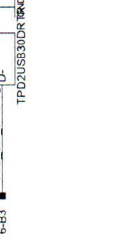
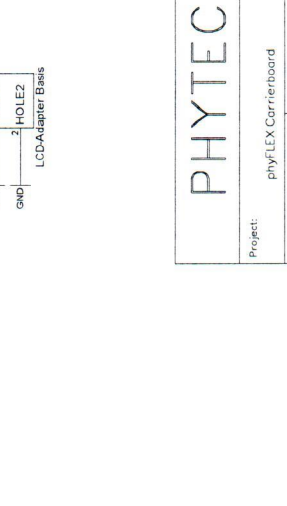
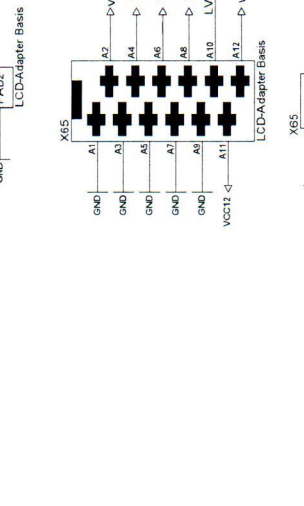
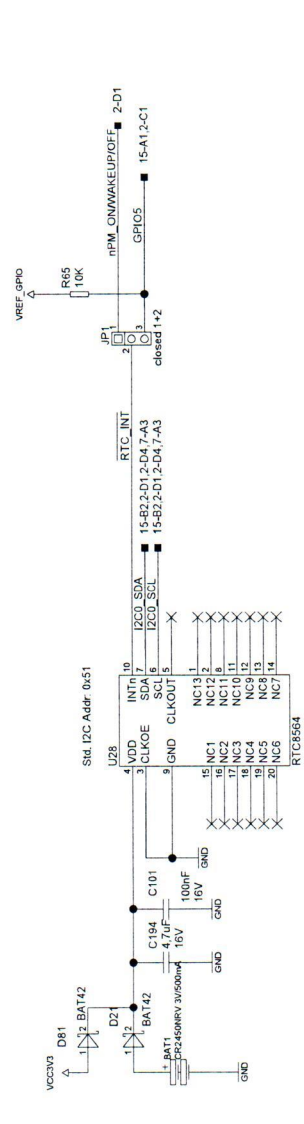
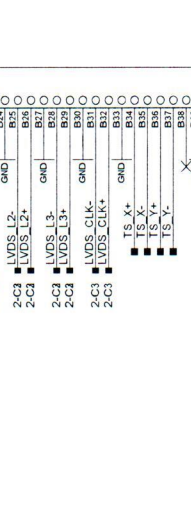
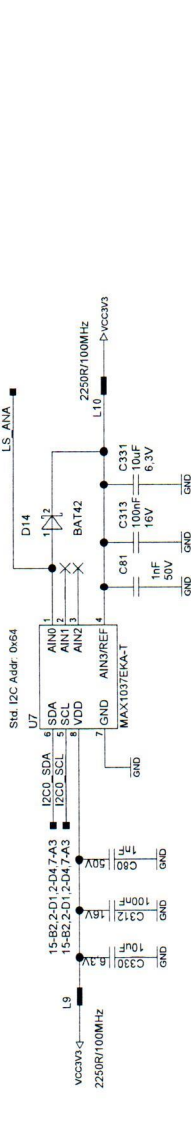
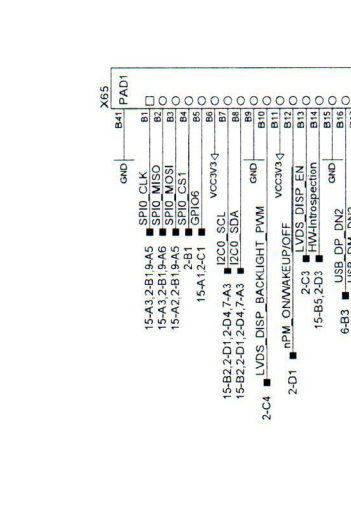
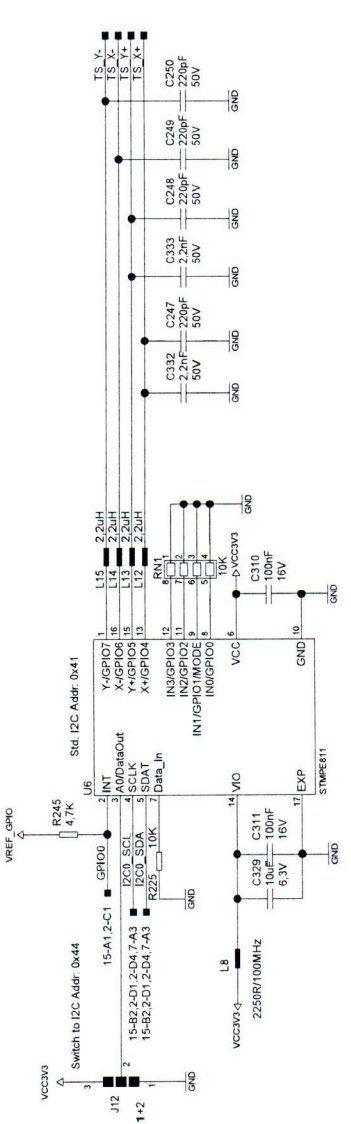

<b>PHYTEC</b>		PHYTEC Messtechnik GmbH Robert-Koch-Strasse 39 D-55129 Mainz
Project:	phyFLEX Carrierboard	Department: F&E Author: M.Achilles
13.05.2013	PCB-No.: 1364.4	Revision: 4
Sheet	8	of 16









# USB0,2,3

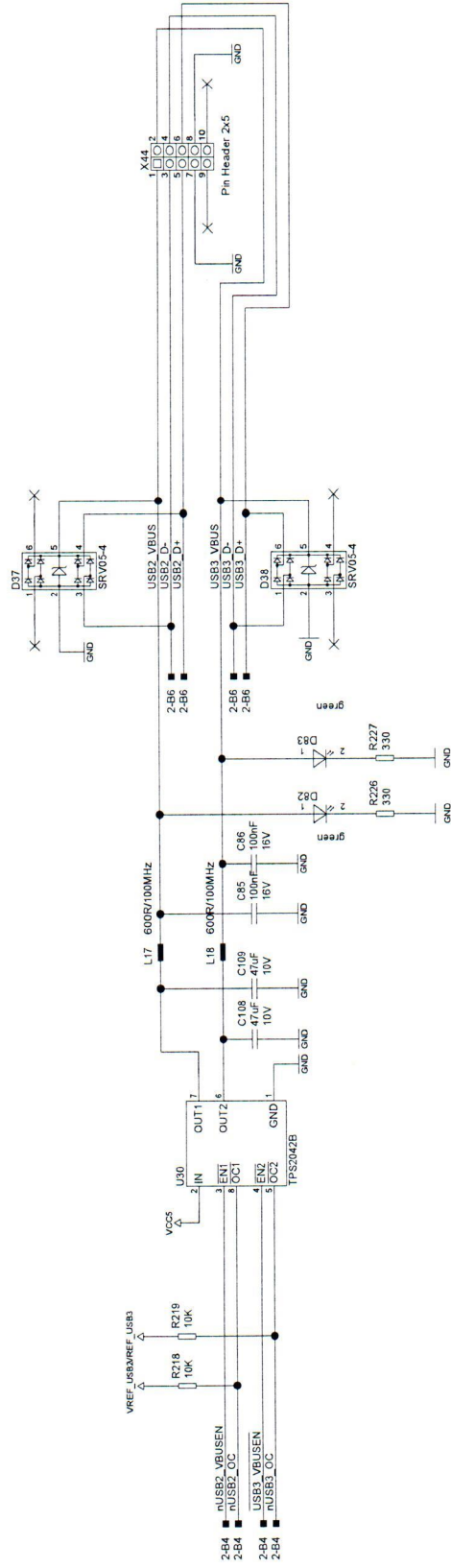

# USB OTG

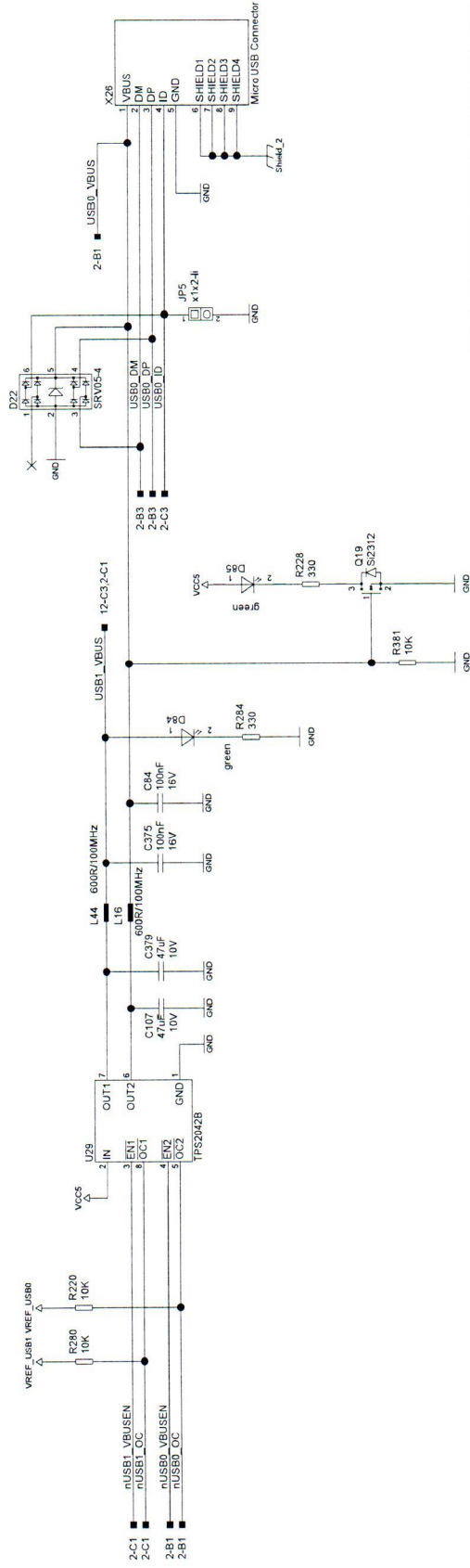

<b>PHYTEC</b>	
Project: phyFLEX Carrierboard	
13.05.2013 PCB-No.: 1364.4	
Department: f&E	Author: M.Achilles
Revision: 4	Sheet: 11 of 16



# Camera\_0/Camera\_1

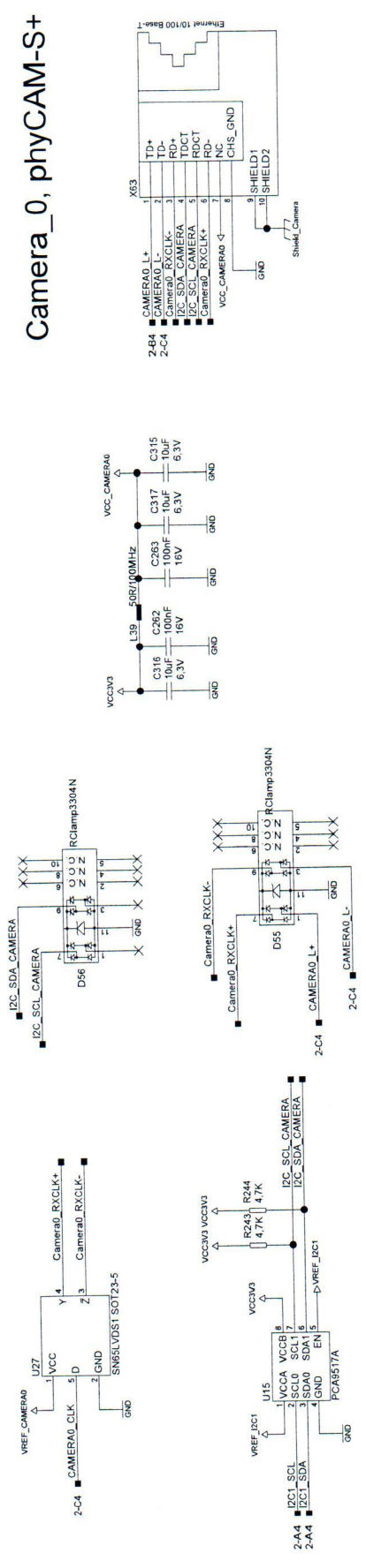

# Camera\_0, phyCAM-S+

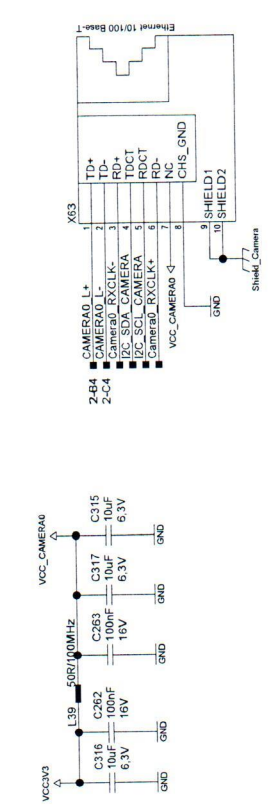

# Camera\_1, phyCAM-S+

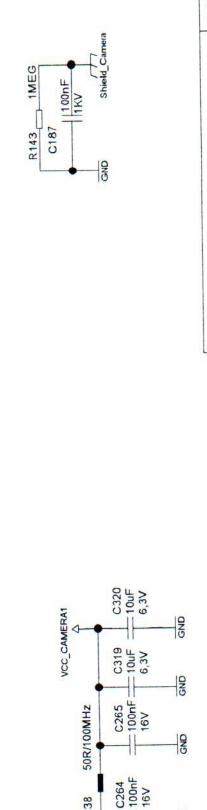
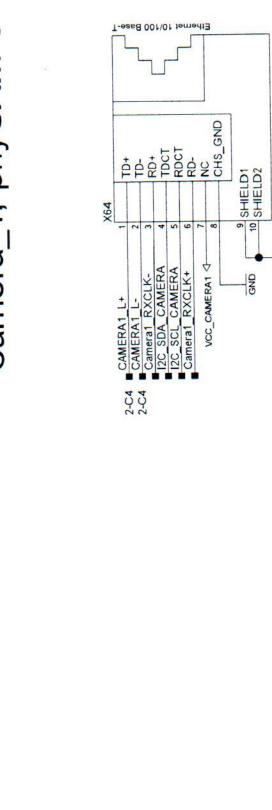

<b>PHYTEC</b>	
PHYTEC Messtechnik GmbH Robert-Koch-Strasse 39 D-55129 Mainz	
Project: phyFLEX Carrierboard	
Department: F&E Author: M.Achilles	
1.3.05.2013	PCB-Nr.: 1.364.4
Revision: 4	Sheet 13 of 16



# CAN

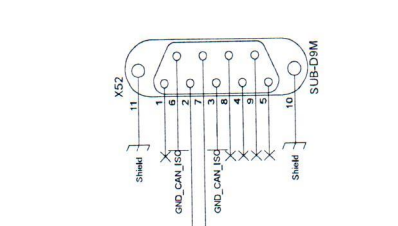
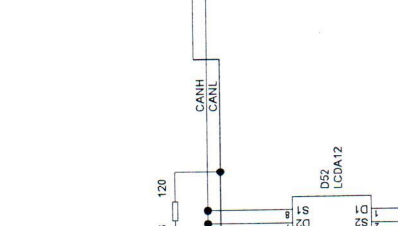
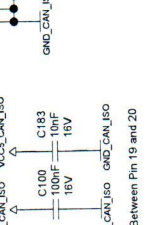
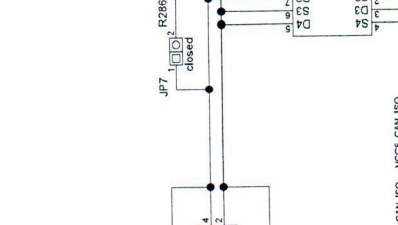
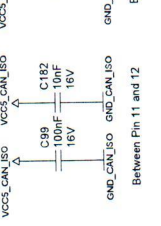
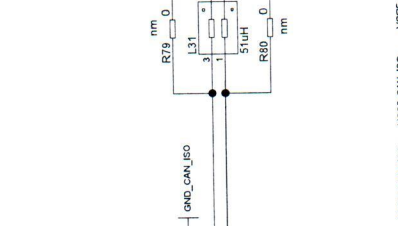
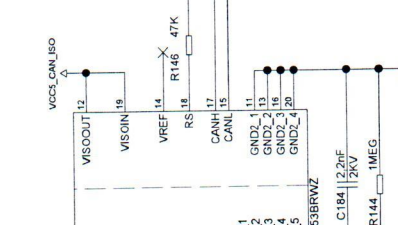
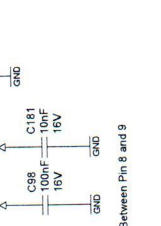
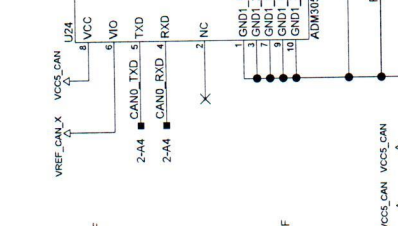
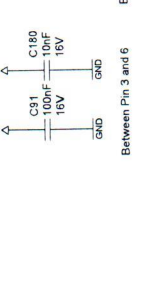
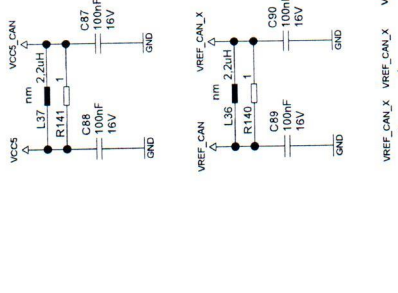

# HDMI/DVI

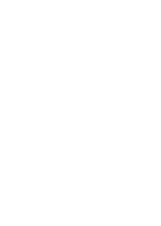
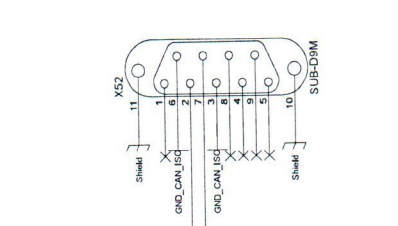
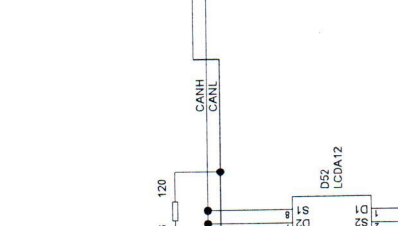
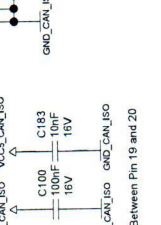
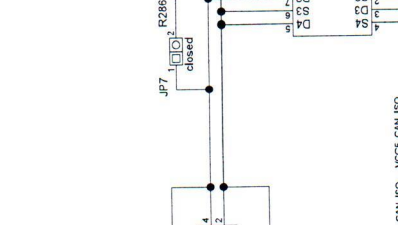
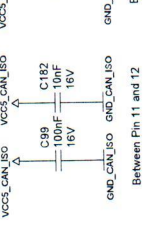
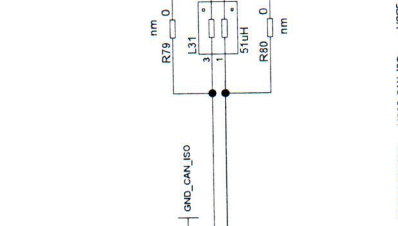
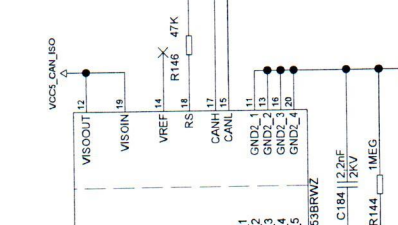
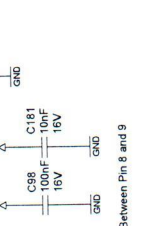
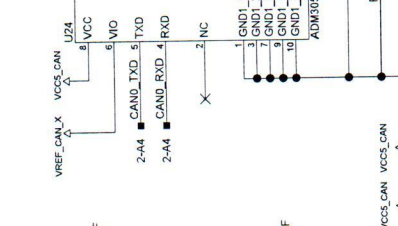
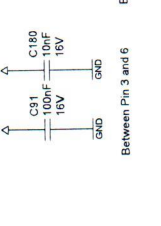
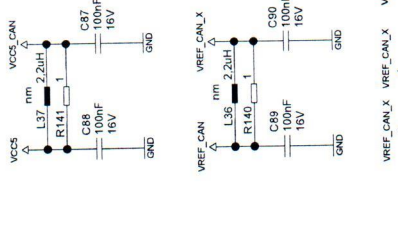
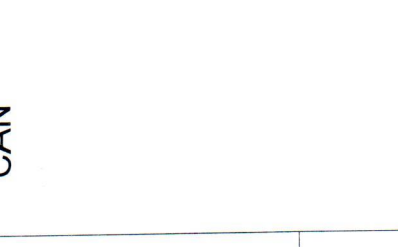

# PHYTEC

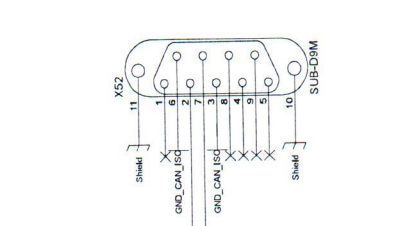
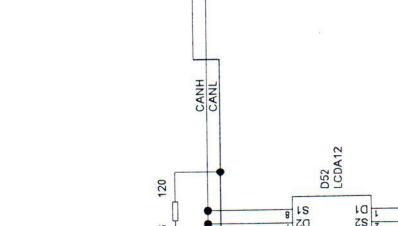
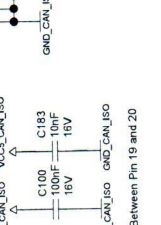
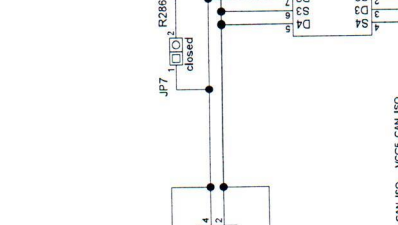
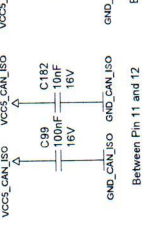
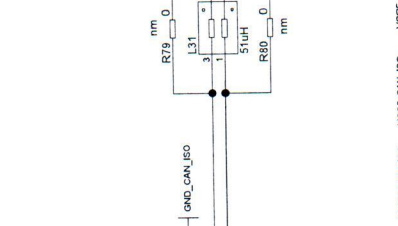
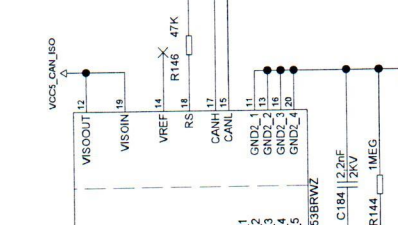
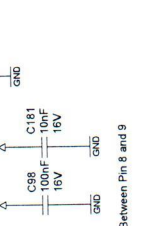
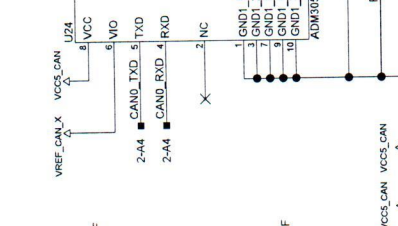
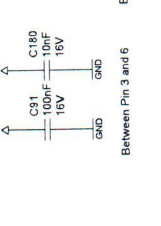
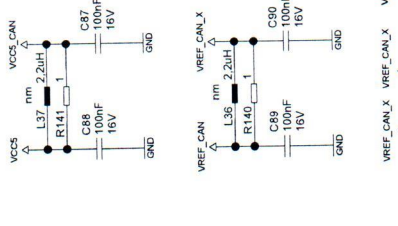
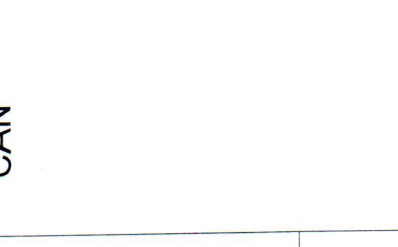

# PHYTEC

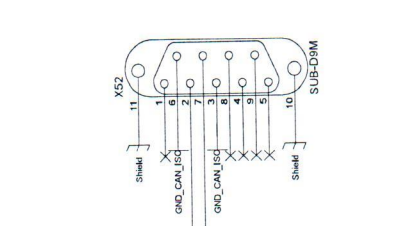
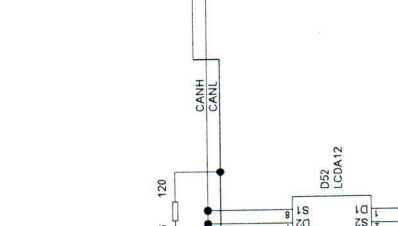
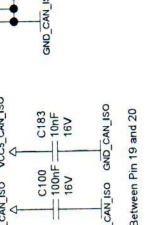
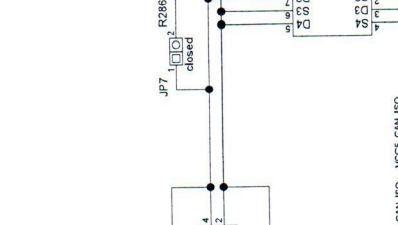
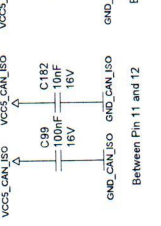
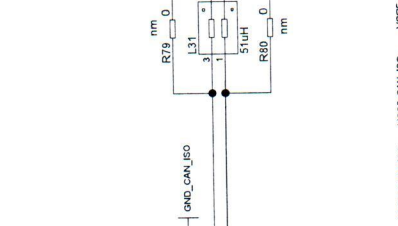
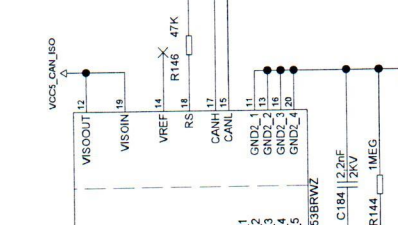
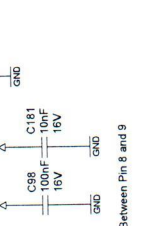
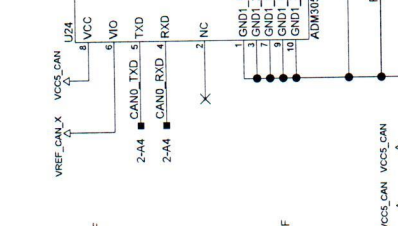
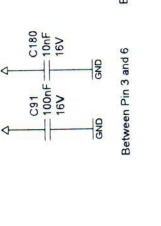
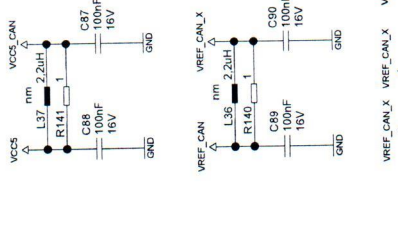
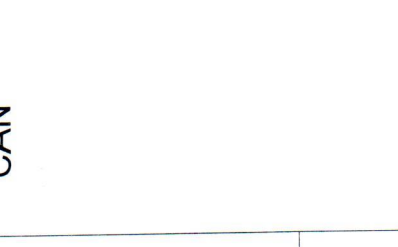

# PHYTEC

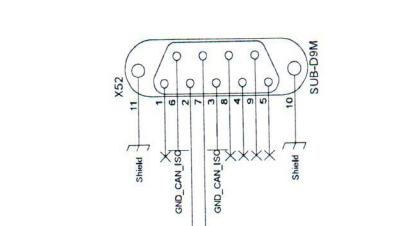
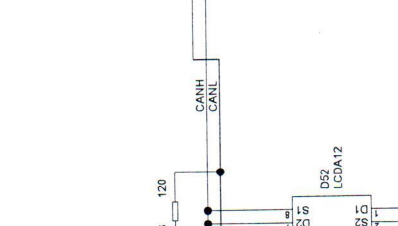
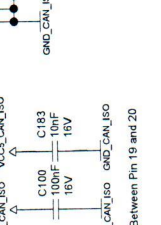
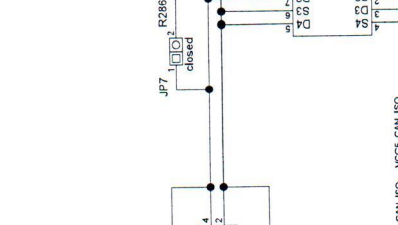
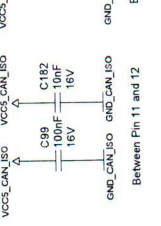
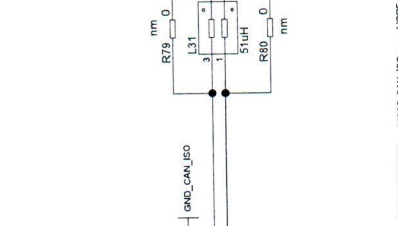
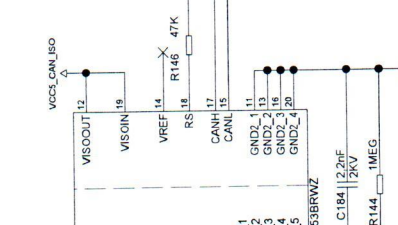
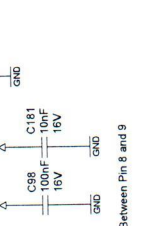
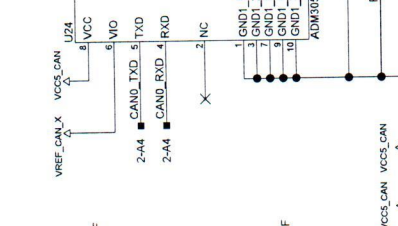
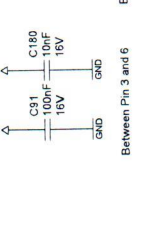
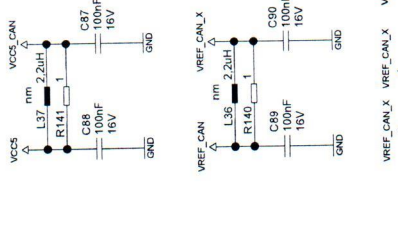
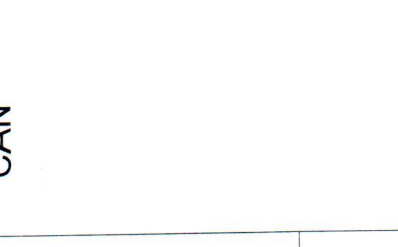

# PHYTEC

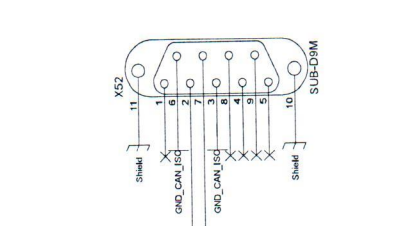
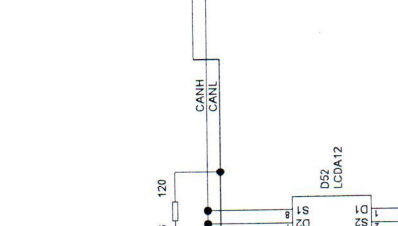
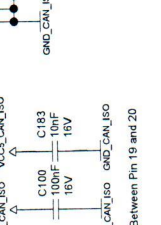
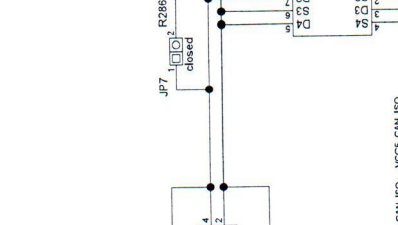
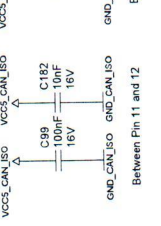
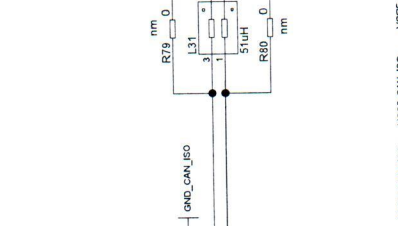
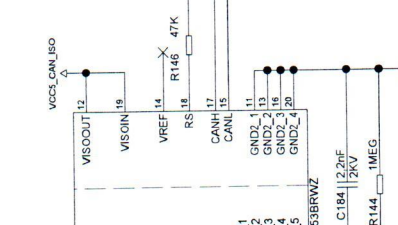
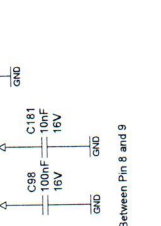
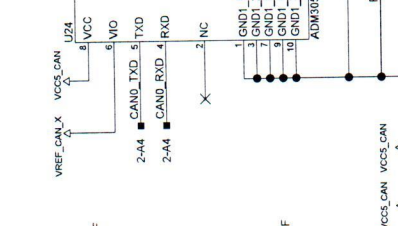
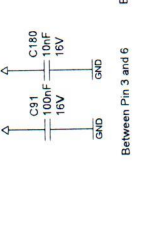
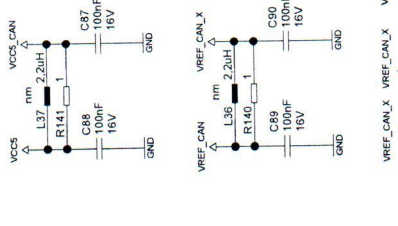
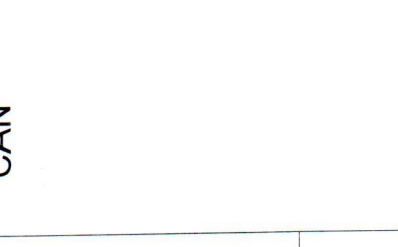

# PHYTEC

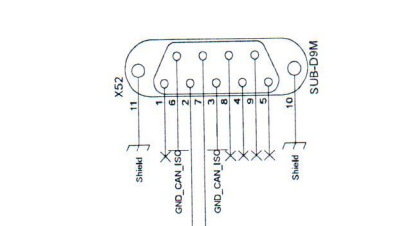
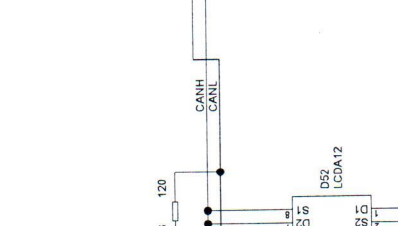
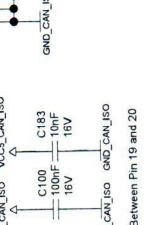
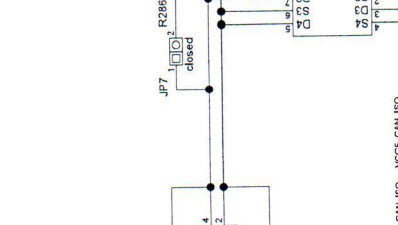
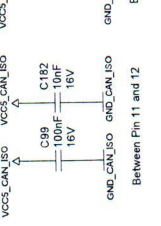
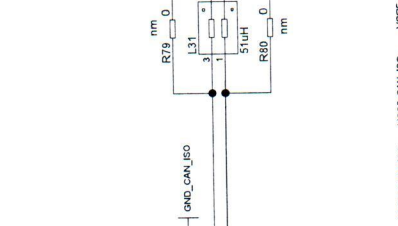
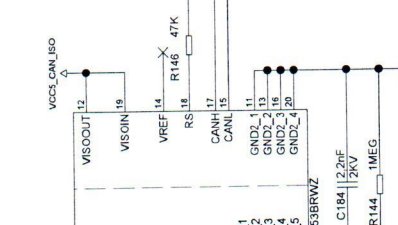
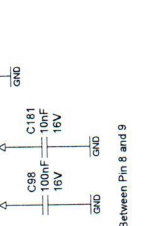
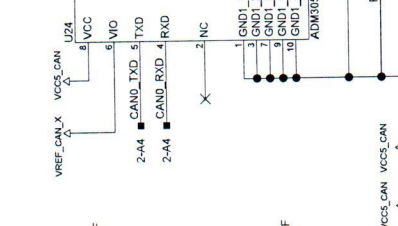
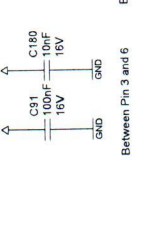
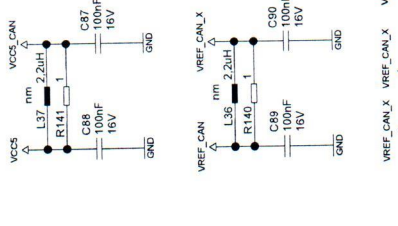
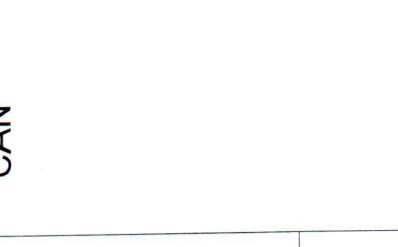

# PHYTEC

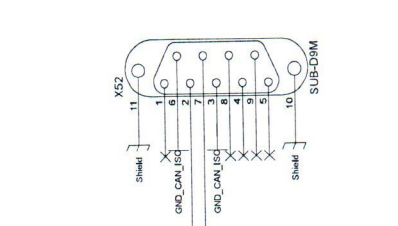
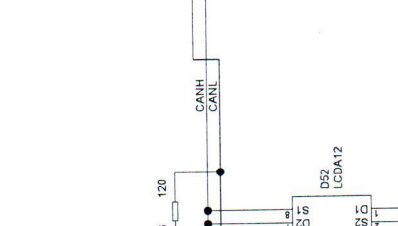
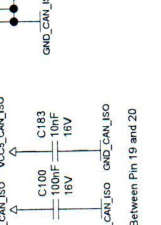
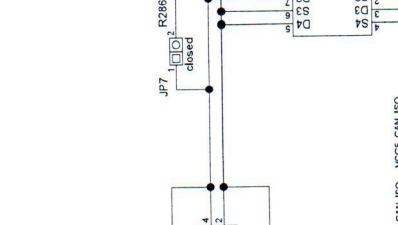
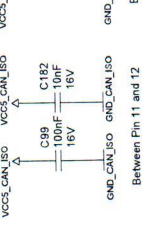
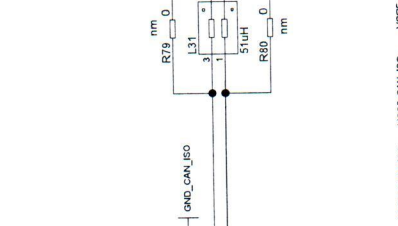
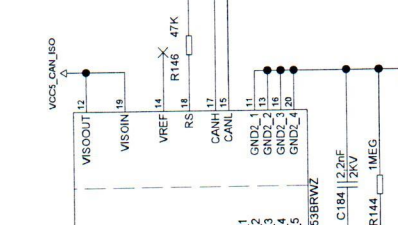
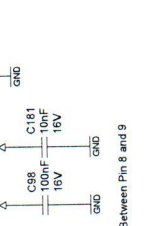
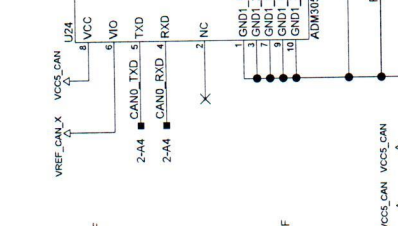
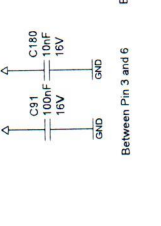
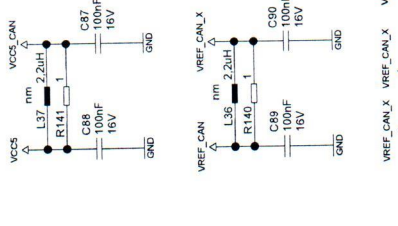
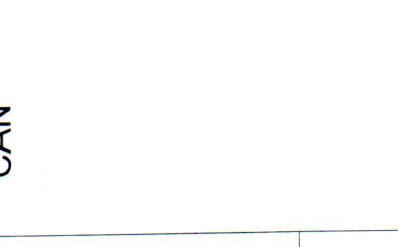

# PHYTEC

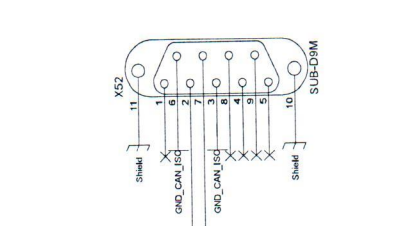
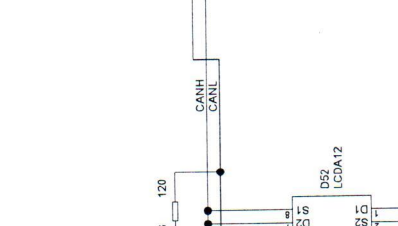
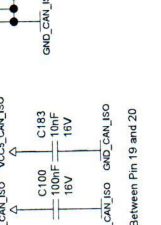
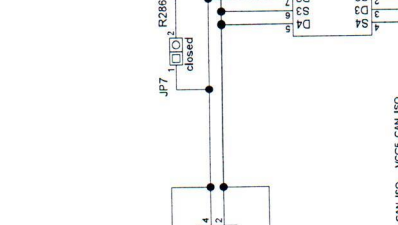
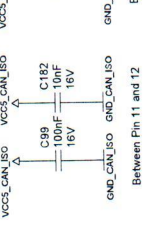
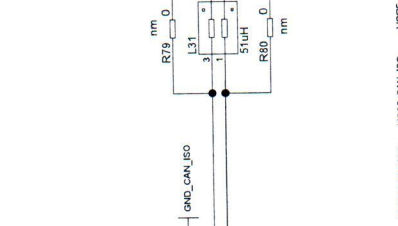
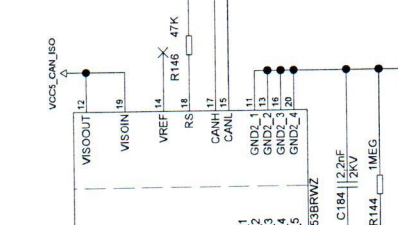
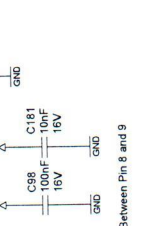
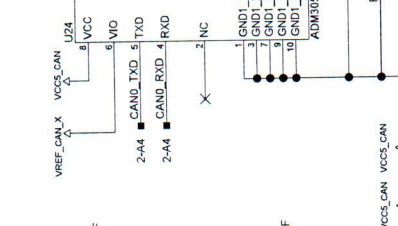
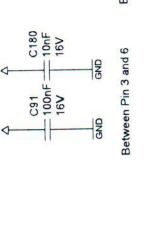
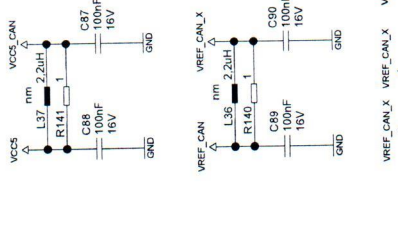
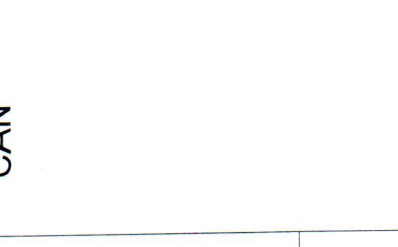

# PHYTEC

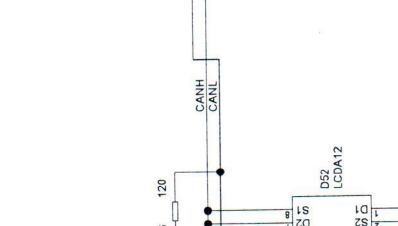
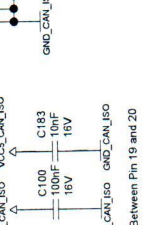
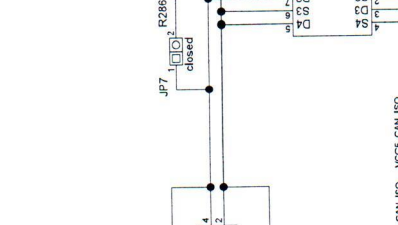
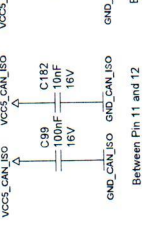
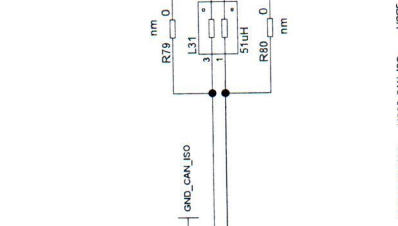
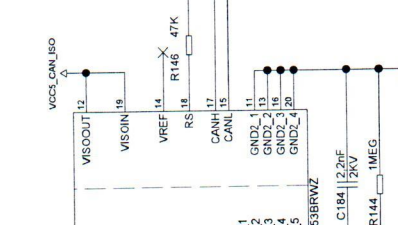
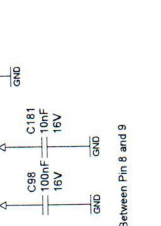
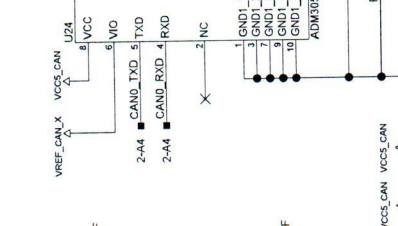
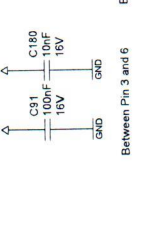
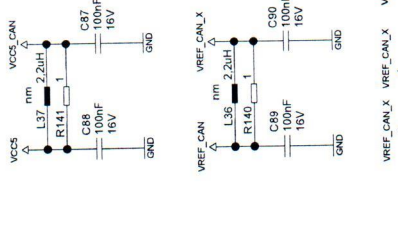
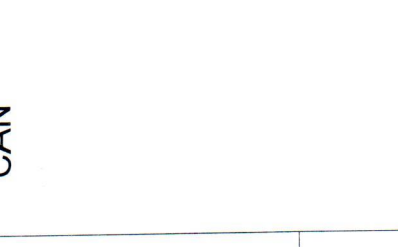

### GPIO

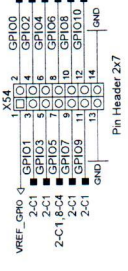

### SPI1

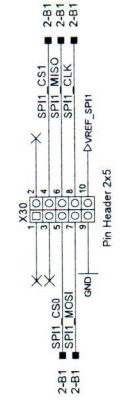

### Power Management

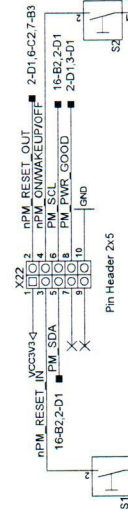

### BOOT Selection

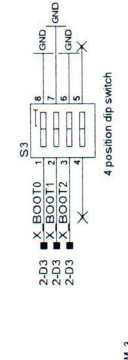

### 1-Wire EEPROM

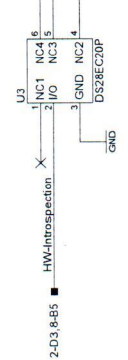

### CPU Fan

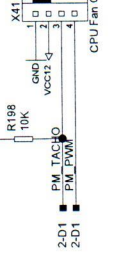

### User LED

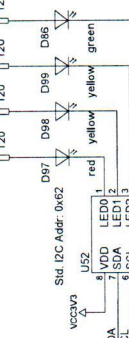

### B

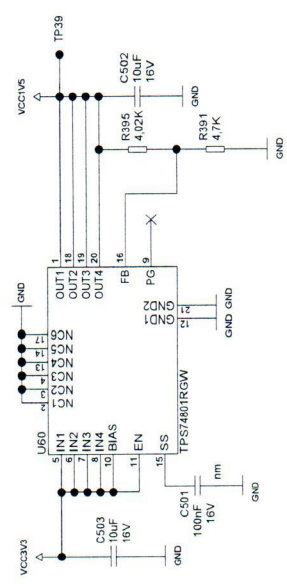

### PCIe0

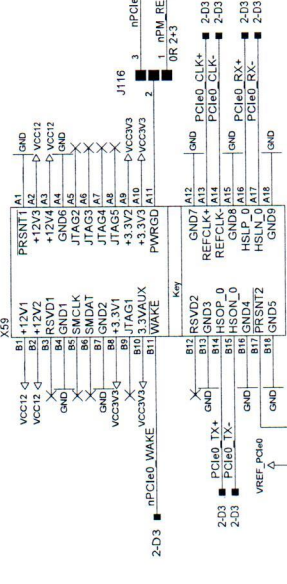

### mini PCIe1

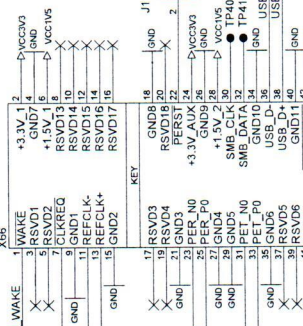

### D

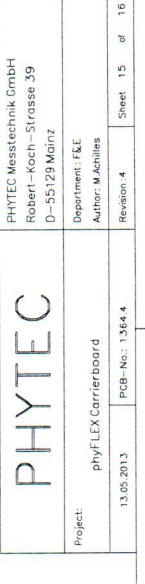

# PHYTEC

PHYTEC Messtechnik GmbH  
Robert-Koch-Strasse 39  
D-55129 Mainz

Project: phyFLEX Carrierboard  
13.05.2013  
PCB-No.: 1364\_4

Department: F&E  
Author: M.Ashles  
Revision: 4



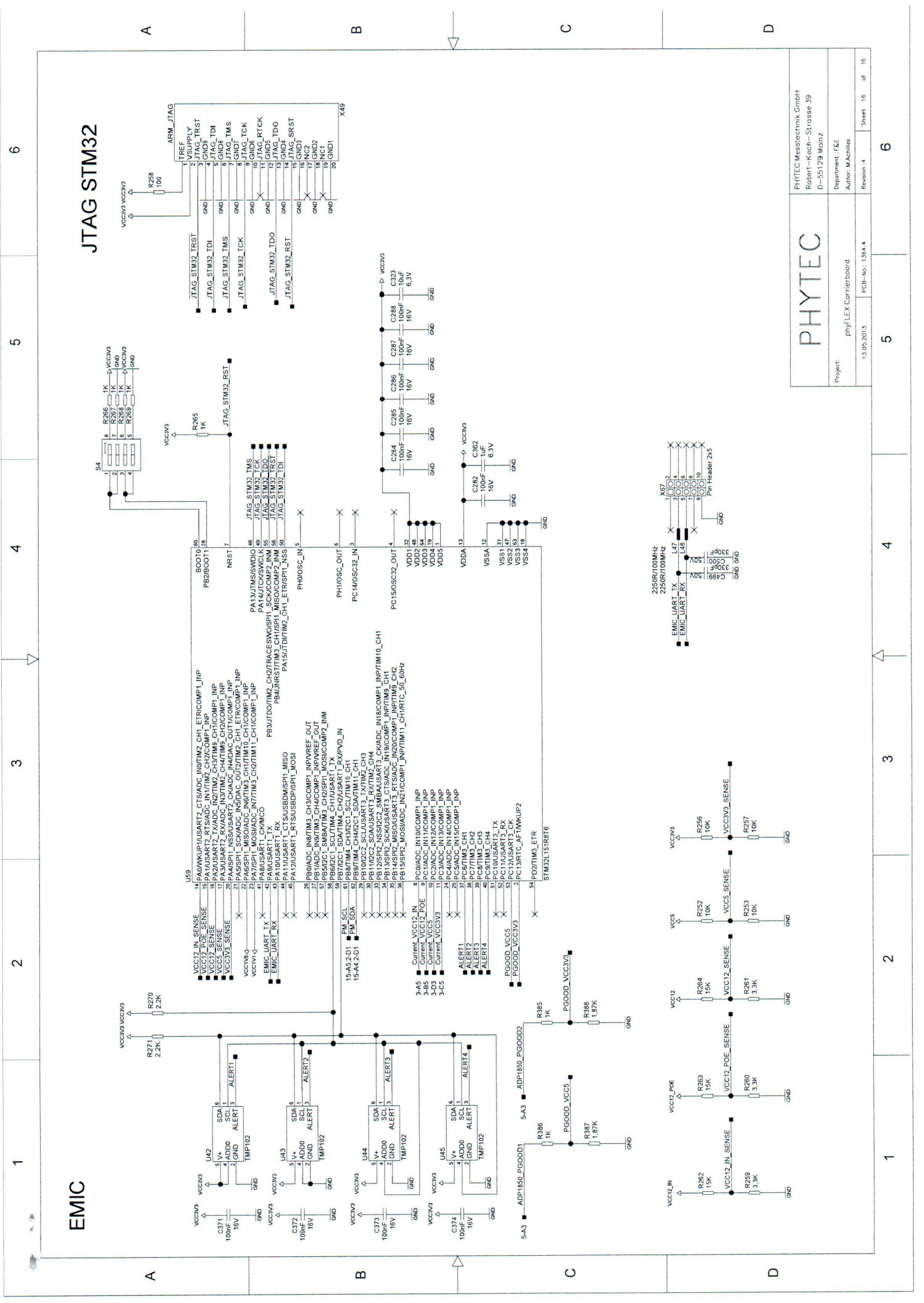

EMIC

JTAG STM32

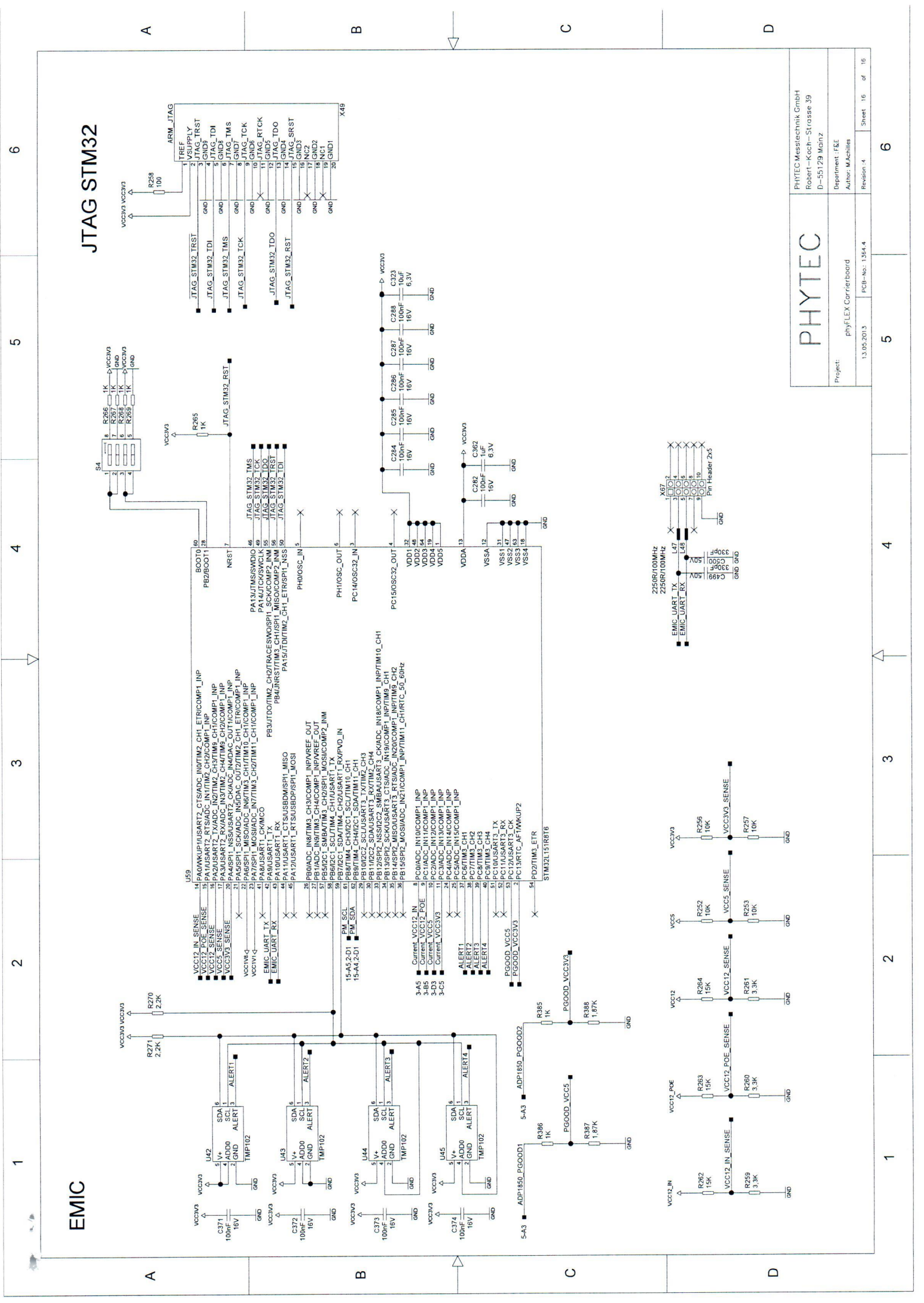

EMIC

JTAG STM32

<b>PHYTEC</b>	
PHYTEC Messtechnik GmbH Robert-Koch-Strasse 39 D-55129 Mainz	
Project:	phyFLEX Carrierboard
13.05.2013	PCB-No.: 1364.4
Revision: 4	Sheet: 16 of 16

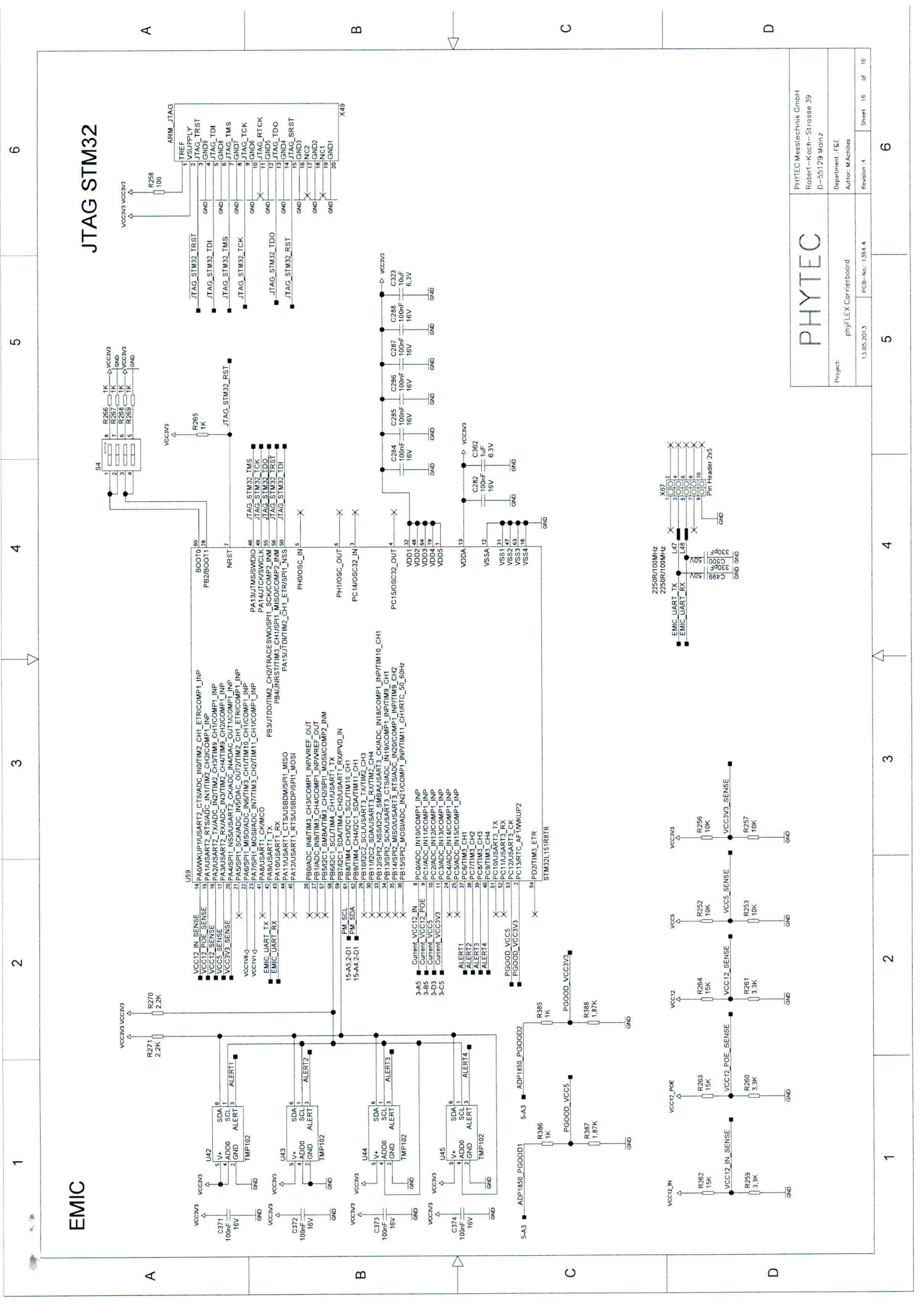

EMIC

JTAG STM32

<b>PHYTEC</b>	
PHYTEC Messtechnik GmbH Robert-Koch-Strasse 39 D-55129 Mainz	
Project:	phyFLEX Carrierboard
13.05.2013	PCB-No.: 1364.4
Revision: 4	Sheet: 16 of 16